

2SK1836, 2SK1837

Silicon N Channel MOS FET

Application

High speed power switching

Features

- Low on-resistance
- High speed switching
- Low drive current
- No secondary breakdown
- Suitable for switching regulator, DC-DC converter

Table 1 Ordering Information

Type No	V_{DSS}
2SK1836	450V
2SK1837	500V

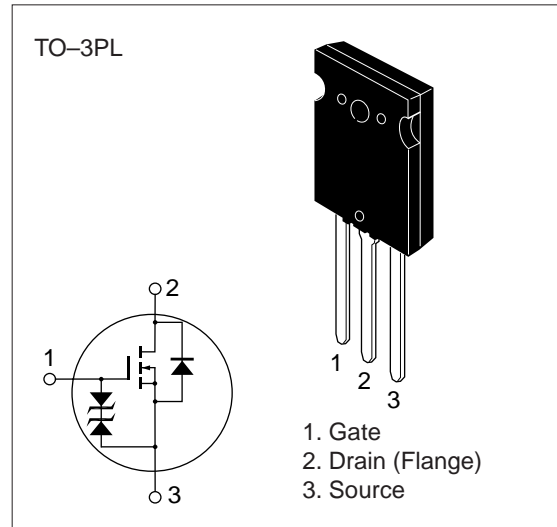

Table 2 Absolute Maximum Ratings ($T_a = 25^\circ\text{C}$)

Item		Symbol	Ratings	Unit
Drain to source voltage	K1836	V_{DSS}	450	V
	K1837		500	
Gate to source voltage		V_{GSS}	± 30	V
Drain current		I_D	50	A
Drain peak current		$I_{D(\text{pulse})}^*$	200	A
Body-drain diode reverse drain current		I_{DR}	50	A
Channel dissipation		P_{ch}^{**}	250	W
Channel temperature		T_{ch}	150	$^\circ\text{C}$
Storage temperature		T_{stg}	-55 to +150	$^\circ\text{C}$

* $PW \leq 10 \mu\text{s}$, duty cycle $\leq 1\%$

** Value at $T_c = 25^\circ\text{C}$

Table 3 Electrical Characteristics (Ta = 25°C)

Item	Symbol	Min	Typ	Max	Unit	Test conditions
Drain to source breakdown voltage	K1836	450	—	—	V	$I_D = 10 \text{ mA}, V_{GS} = 0$
	K1837	500	—	—		
Gate to source breakdown voltage	$V_{(BR)GSS}$	± 30	—	—	V	$I_G = \pm 100 \mu\text{A}, V_{DS} = 0$
Gate to source leak current	I_{GSS}	—	—	± 10	μA	$V_{GS} = \pm 25 \text{ V}, V_{DS} = 0$
Zero gate voltage drain current	K1836	—	—	250	μA	$V_{DS} = 360 \text{ V}, V_{GS} = 0$
	K1837	—	—	—		$V_{DS} = 400 \text{ V}, V_{GS} = 0$
Gate to source cutoff voltage	$V_{GS(off)}$	2.0	—	3.0	V	$I_D = 1 \text{ mA}, V_{DS} = 10 \text{ V}$
Static drain to source on state resistance	K1836	—	0.08	0.10	Ω	$I_D = 25 \text{ A}$ $V_{GS} = 10 \text{ V}^*$
	K1837	—	0.085	0.11		
Forward transfer admittance	$ y_{fs} $	22	35	—	S	$I_D = 25 \text{ A}$ $V_{DS} = 10 \text{ V}^*$
Input capacitance	C_{iss}	—	8150	—	pF	$V_{DS} = 10 \text{ V}$
Output capacitance	C_{oss}	—	2100	—	pF	$V_{GS} = 0$
Reverse transfer capacitance	C_{rss}	—	180	—	pF	$f = 1 \text{ MHz}$
Turn-on delay time	$t_{d(on)}$	—	80	—	ns	$I_D = 25 \text{ A}$
Rise time	t_r	—	250	—	ns	$V_{GS} = 10 \text{ V}$
Turn-off delay time	$t_{d(off)}$	—	550	—	ns	$R_L = 1.2 \Omega$
Fall time	t_f	—	220	—	ns	
Body-drain diode forward voltage	V_{DF}	—	1.1	—	V	$I_F = 50 \text{ A}, V_{GS} = 0$
Body-drain diode reverse recovery time	t_{rr}	—	620	—	ns	$I_F = 50 \text{ A}, V_{GS} = 0,$ $di_F / dt = 100 \text{ A} / \mu\text{s}$

* Pulse Test

Power vs. Temperature Derating

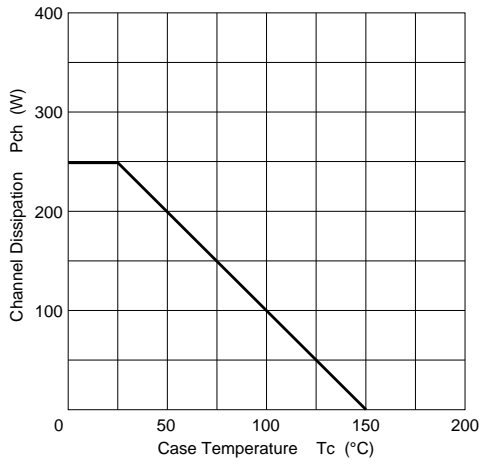

Maximum Safe Operation Area

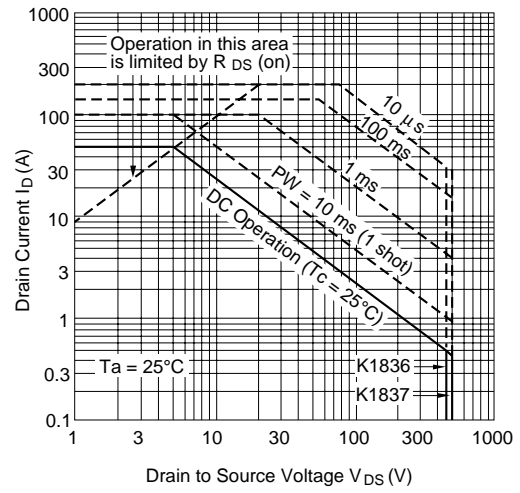

Typical Output Characteristics

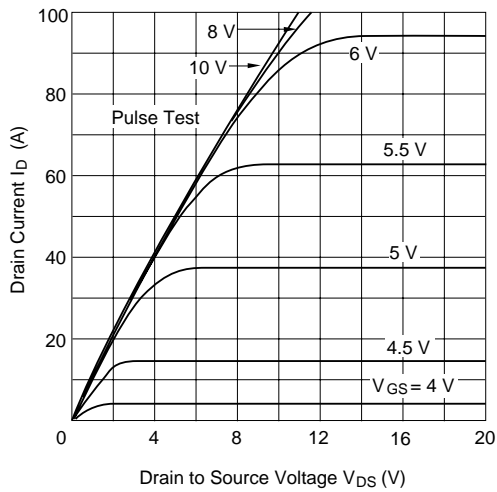

Typical Transfer Characteristics

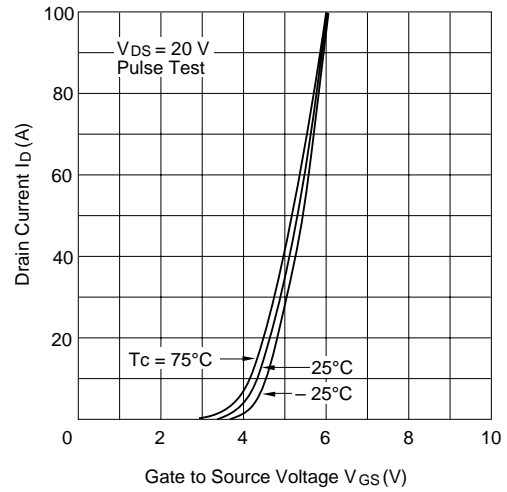

Drain-Source Saturation Voltage vs. Gate-Source Voltage

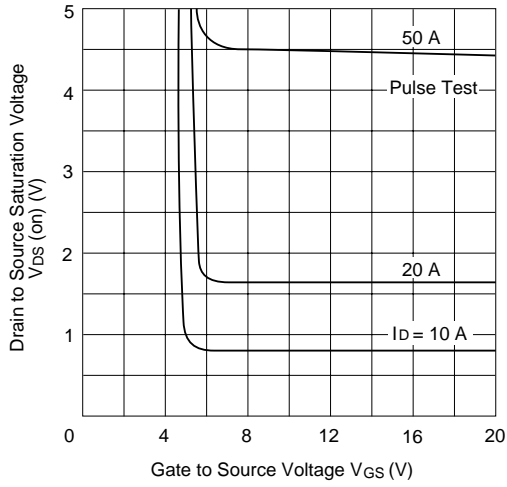

Static Drain-Source on State Resistance vs. Drain Current

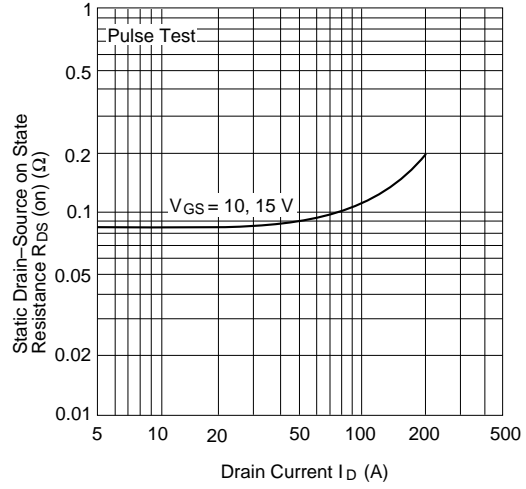

Static Drain-Source on State Resistance vs. Temperature

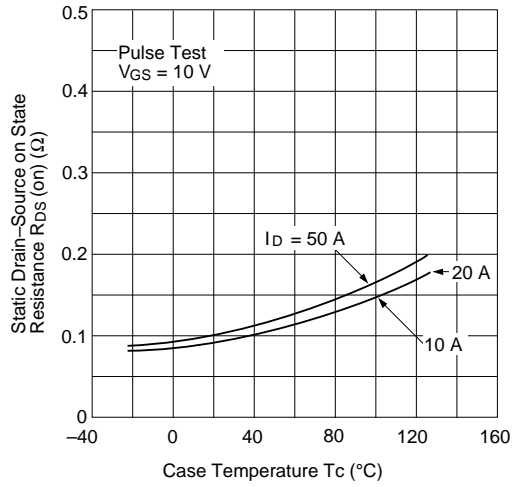

Forward Transfer Admittance vs. Drain Current

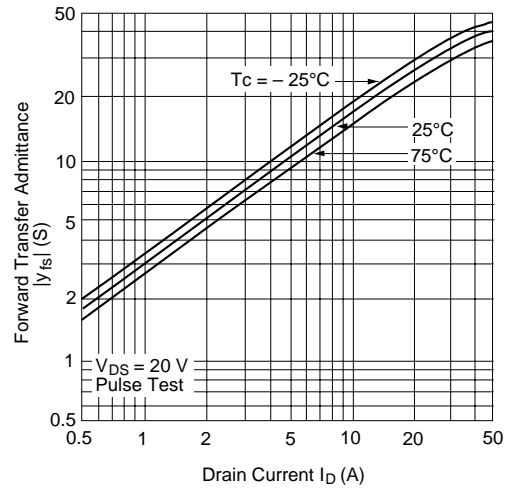

Body-Drain Diode Reverse Recovery Time

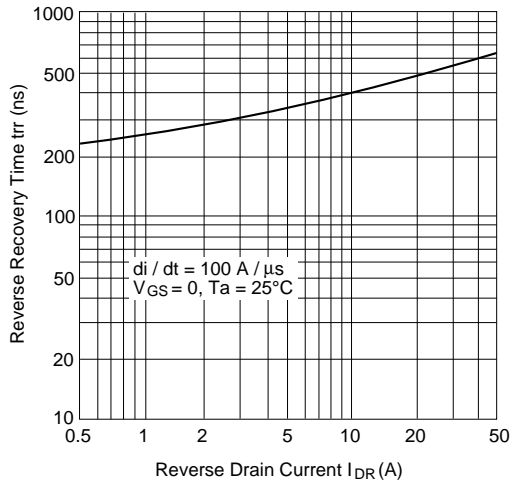

Typical Capacitance vs. Drain-Source Voltage

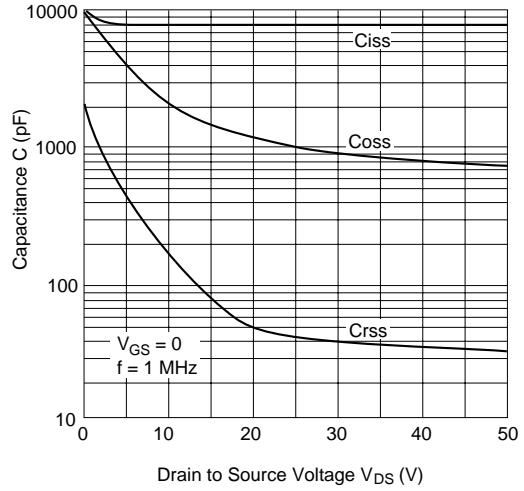

Dynamic Input Characteristics

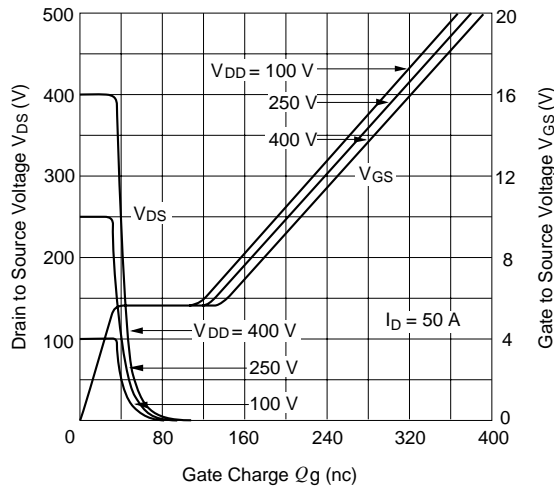

Switching Characteristics

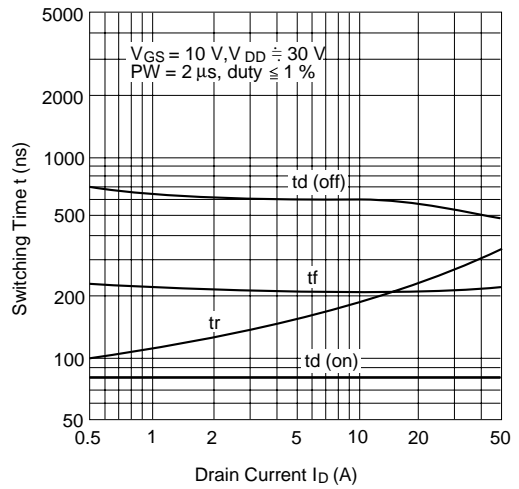

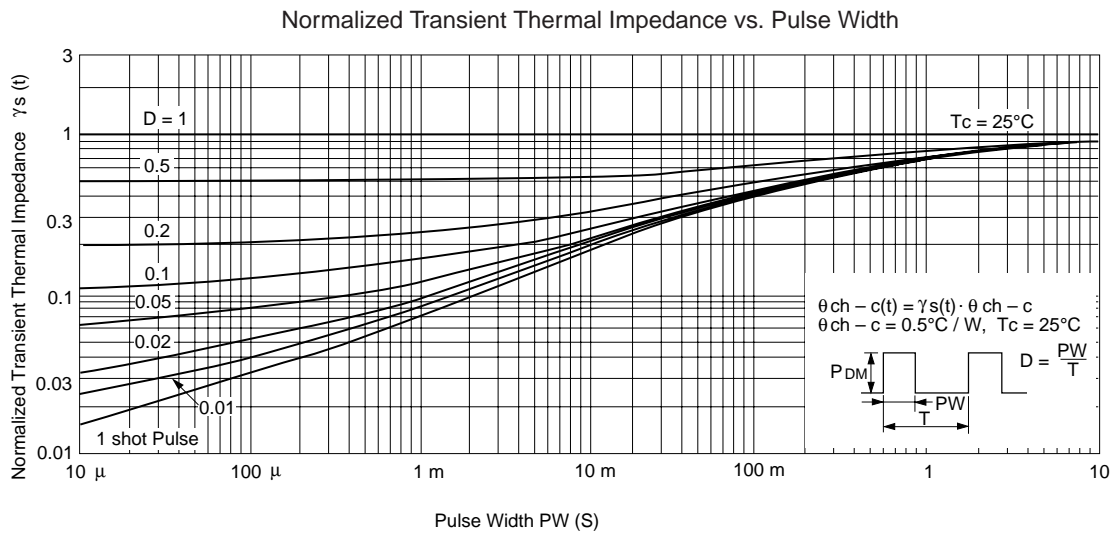
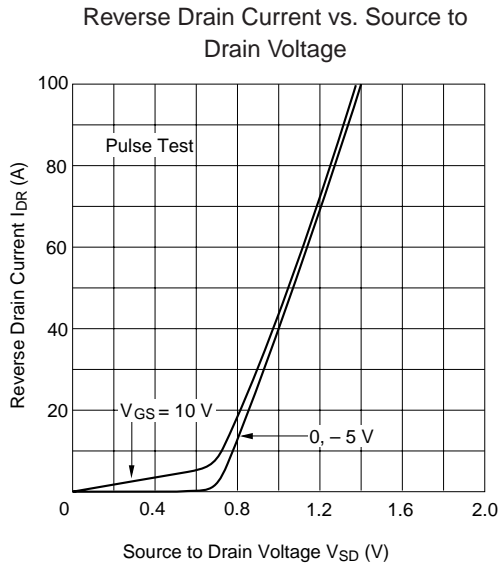

Switching Time Test Circuit

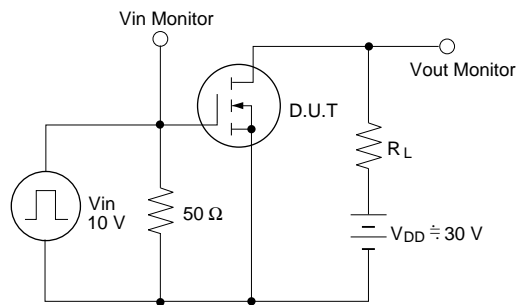

Waveforms

